

Spherical plain bearing

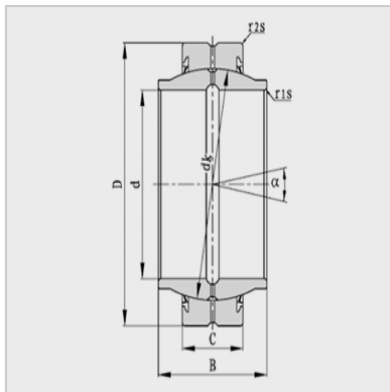
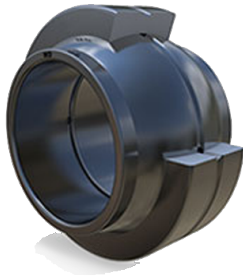

Modell : GE80LO

Hauptgr ö ß e (mm) :

d : 80

d2 (min) : 91

D : 120

B : 80

C : 45

dk : 105

r1s (min) : 1

r2s (min) : 1

° : 4

Nennlast (KN) :

Cr : 400

Cor : 2000

Gewicht (kg) : 2.4

: