

Lagersitz

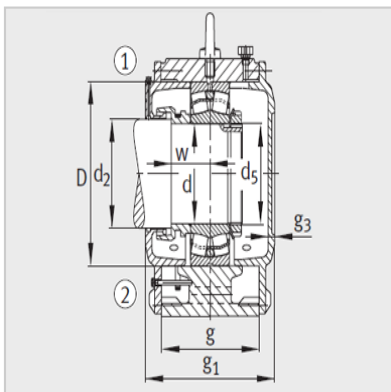
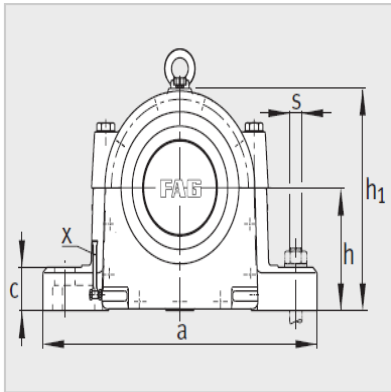
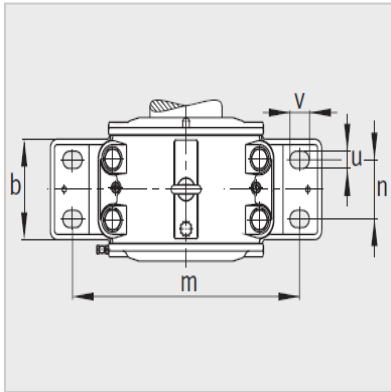

Modell :

Positionierung des Lagersitzes :	LOE626-N-BF-L
Schwabender Lagersitz :	LOE626-N-BL-L
Lager :	22326-E1-K
Spannhülse :	H2326
Anfangsölinjektionsmenge l :	3.7
Ölstandhöhe x mm :	75-105
Masse m Lagersitz kg :	142

Größe :

d ₁ :	115
a :	660
g ₁ :	315
h ₁ :	420
b :	200
c :	80
D :	280
g :	220
g ₃ :	-
h :	235
m :	530
n :	110
u :	42
v :	60
s :	M36

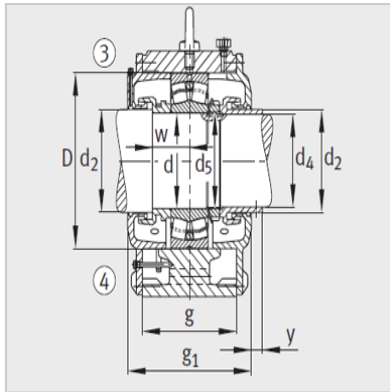

: